

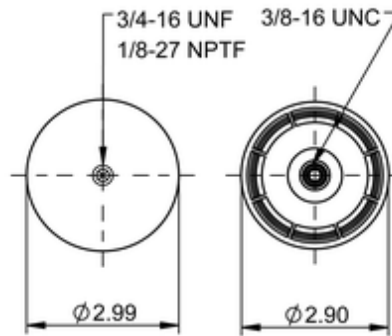

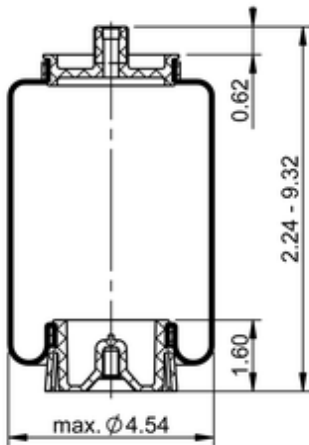



SC29-O076

78411



	0.9 lb
	9310094
	1/8-27 NPTF: max. 1.5 lbf ft
	3/4-16 UNF: max. 9 lbf ft
	3/8-16 UNC: max. 3.5 lbf ft

Cross-reference

Firestone No.	W02-358-7076
---------------	--------------

OE Manufacturer/Part No.

Manufacturer	Original Part No.	Model
--------------	-------------------	-------

