

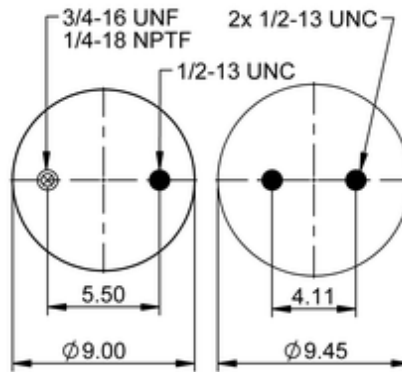

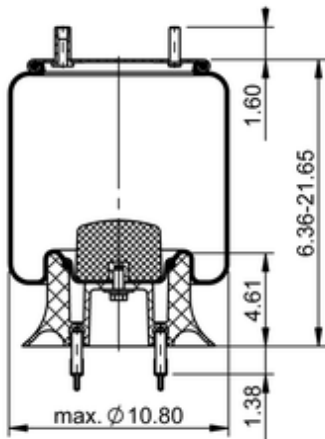



**9 9K-16 P 1568**

**600804**



	12.8 lb
	9317208
	1/2-13 UNC: max. 35 lbf ft
	1/8-27 NPTF: max. 18 lbf ft
	3/4-16 UNF: max. 50 lbf ft

**Cross-reference**

Firestone No.	W01-358-8965
---------------	--------------

**OE Manufacturer/Part No.**

Manufacturer	Original Part No.	Model
--------------	-------------------	-------

