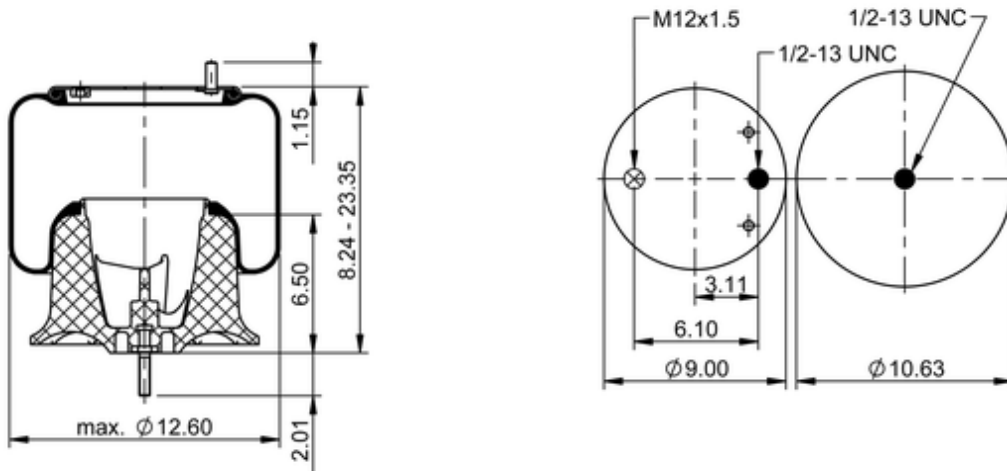

9 10S-16 P 1600
601538

	13.7 lb
	9314025
	1/2-13 UNC: max. 35 lbf ft
	M12x1.5: max. 22 lbf ft

OE Manufacturer/Part No.

Manufacturer	Original Part No.	Model
Freightliner	A16-21557-001	
Freightliner	A16-21557-000	