

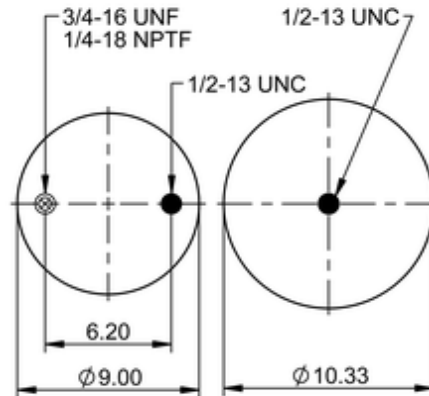

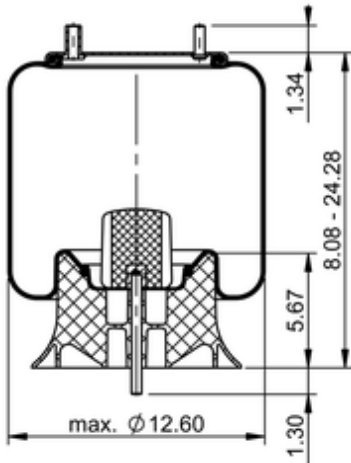



9 10-19 P 809

65396



 lb	16.1 lb
	9314552
	1/2-13 UNC: max. 35 lbf ft
	1/4-18 NPTF: max. 22 lbf ft
	3/4-16 UNF: max. 50 lbf ft

Cross-reference

Automann	1DK23L-P809
----------	-------------

OE Manufacturer/Part No.

Manufacturer	Original Part No.	Model
Link	1103 0061	

