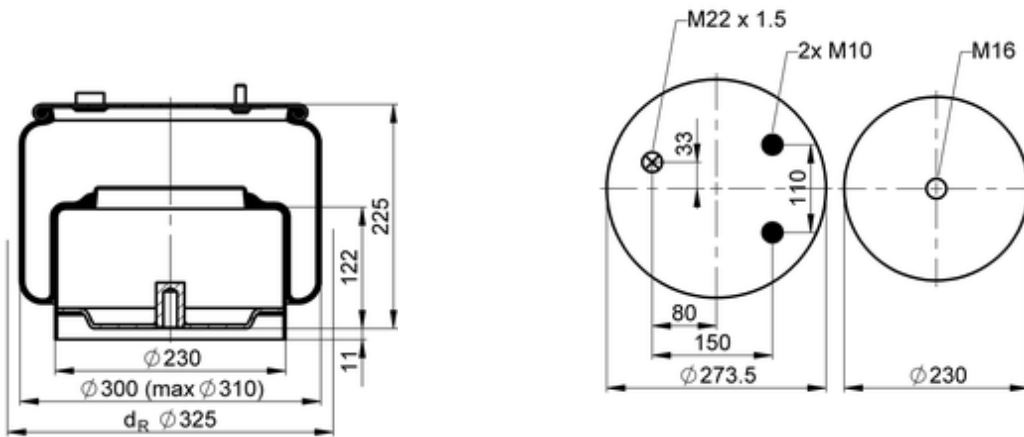

836 N P12
78199

bolt or stud
 hole
 combination stud
 air inlet
 stud and nut

	7,5 kg
	10087198
	M10: max. 45 Nm
	M16: max. 170 Nm
	M22x1.5: max. 20 Nm

OE Manufacturer/Part No.

Manufacturer	Original Part No.	Model
DAF	1 794 422	