

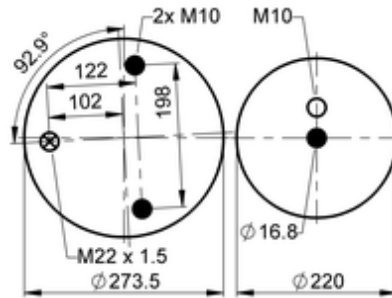

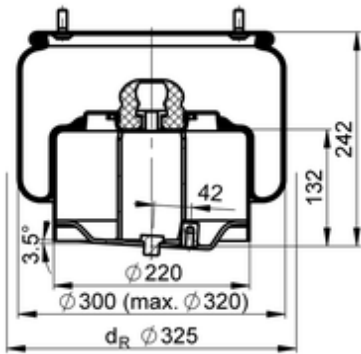







6753 N P02 L

601903



-  bolt or stud
-  hole
-  combination stud
-  air inlet
-  stud and nut

	9 kg
	10087504
	
	M10: max. 45 Nm
	M22x1.5: max. 20 Nm

OE Manufacturer/Part No.

Manufacturer	Original Part No.	Model
DAF	1 882 449	LOW Left