

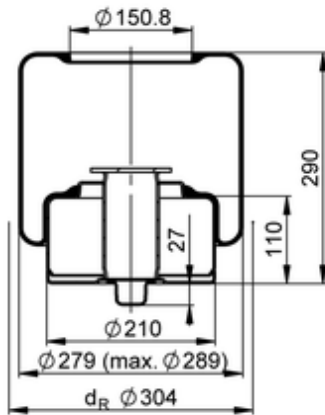







6638 N P01

600715



-  bolt or stud
-  hole
-  combination stud
-  air inlet
-  stud and nut

	5,8 kg
	

OE Manufacturer/Part No.

Manufacturer	Original Part No.	Model
Volvo	22 007 140	9700, B11R