

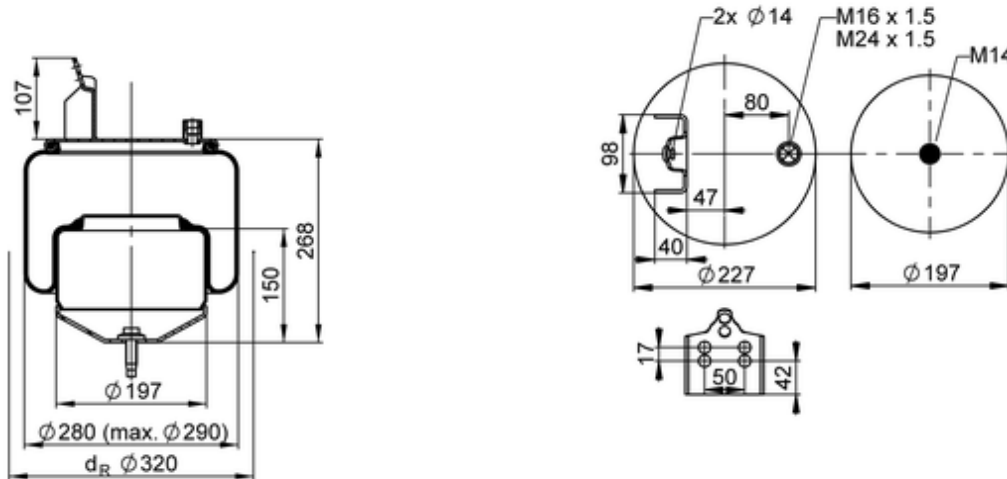











6606 N P01

63369



 bolt or stud  
  hole  
  combination stud  
  air inlet  
  stud and nut

 kg	6,4 kg
	K005
	
	M14: max. 120 Nm
	M16x1.5: max. 20 Nm
	M24x1.5: max. 60 Nm

### OE Manufacturer/Part No.

Manufacturer	Original Part No.	Model
Volvo	20 427 805	
Volvo	20 427 804	
Volvo	20 427 801	FH 12 medium
Volvo	20 456 154	FH 12 medium
Volvo	20 375 227	FH 12 medium

Volvo	20 531 986	FH 12 medium
Volvo	20 582 209	FM / FH medium
Volvo	21 961 443	FM / FH medium