

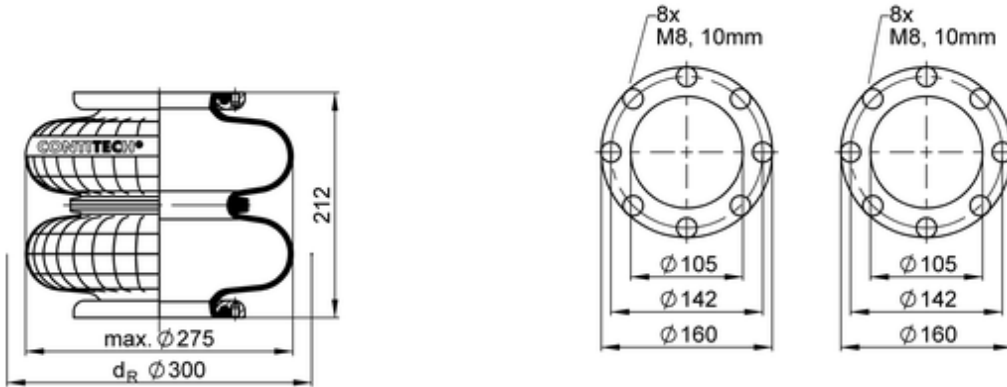







620 M

2680898006



-  bolt or stud
-  hole
-  combination stud
-  air inlet
-  stud and nut

	4 kg
	M8: max. 25 Nm

OE Manufacturer/Part No.

Manufacturer	Original Part No.	Model
BPW	05.419.00.28.0	