

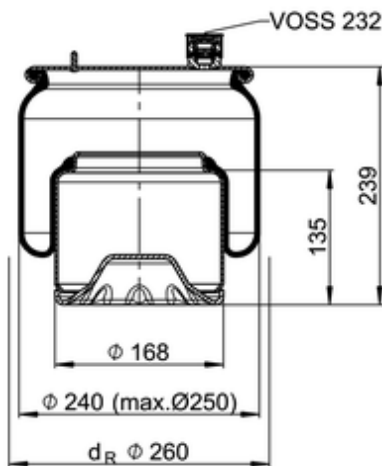







6127 N P40

74989



-  bolt or stud
-  hole
-  combination stud
-  air inlet
-  stud and nut

	5,5 kg
	10087052
	

OE Manufacturer/Part No.

Manufacturer	Original Part No.	Model
Mercedes	960 320 03 21	
Mercedes	A 960 320 03 21	Actros MP4