

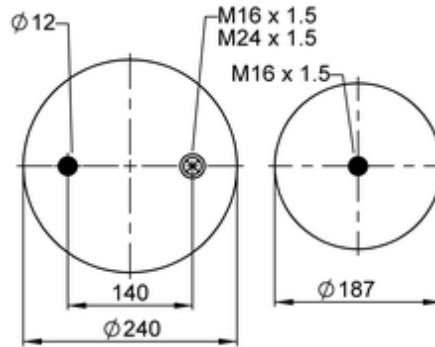

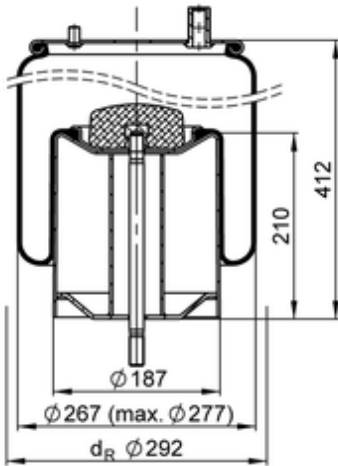









4915 N P06

67722



-  bolt or stud
-  hole
-  combination stud
-  air inlet
-  stud and nut

 kg	10,6 kg
	10086792
	K018
	
	M16x1.5: max. 180 Nm
	M16x1.5: max. 40 Nm
	M24x1.5: max. 40 Nm

OE Manufacturer/Part No.

Manufacturer	Original Part No.	Model
SAMRO	H2501122	
Renault	5.010.557.991	
Renault	5.010.294.309	Premium / Magnum tag
Renault	5.010.600.578	Premium / Magnum tag

Renault	7.422.190.563	Premium / Magnum tag
Volvo	20 757 541	FM / FH
Volvo	22 025 613	FM / FH