

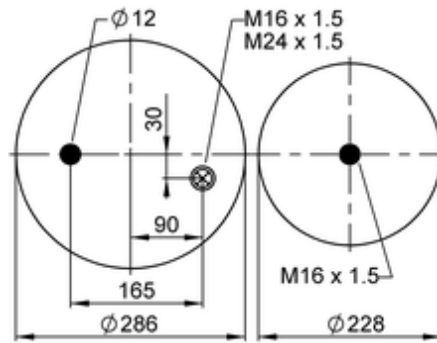

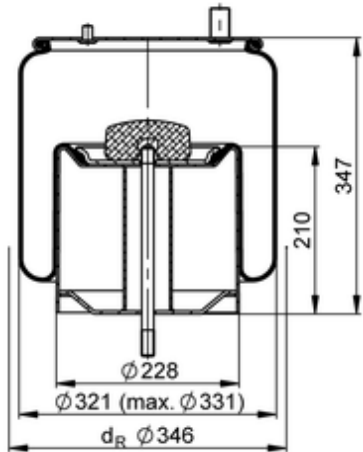









4911 N P04

67719



 bolt or stud   
  hole   
  combination stud   
  air inlet   
  stud and nut

 kg	13,5 kg
	10086791
	K018
	
	M16x1.5: max. 180 Nm
	M16x1.5: max. 80 Nm
	M24x1.5: max. 120 Nm

### OE Manufacturer/Part No.

Manufacturer	Original Part No.	Model
Renault	5.010.557.356	Premium / Magnum low
Renault	22 190 560	Premium / Magnum low
Renault	7.422.190.560	Premium / Magnum low

