

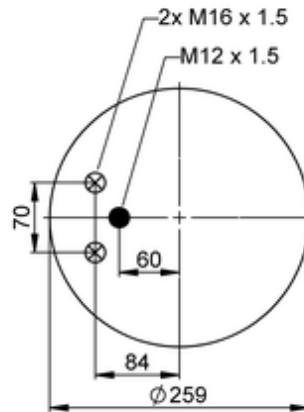

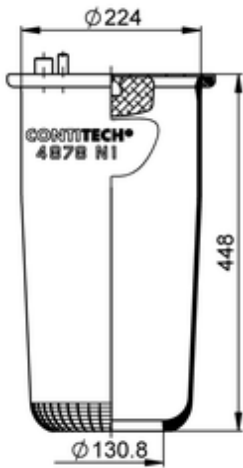







4878 N1 P02

78122



-  bolt or stud
-  hole
-  combination stud
-  air inlet
-  stud and nut

 kg	4,5 kg
	10087183
	M12x1.5: max. 40 Nm
	M16x1.5: max. 40 Nm

OE Manufacturer/Part No.

Manufacturer	Original Part No.	Model
MAN	81.43601.0167	low frame