

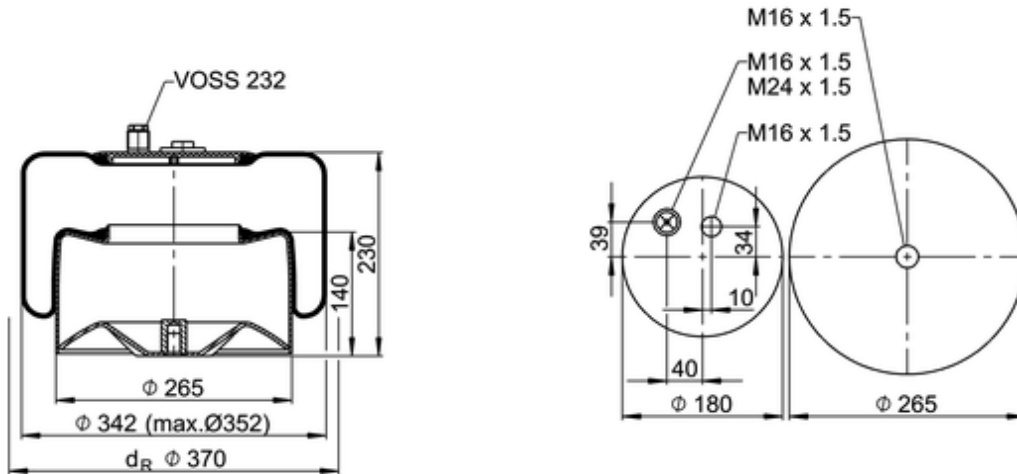













4186 N P25

600145



 bolt or stud   
  hole   
  combination stud   
  air inlet   
  stud and nut

 kg	8,7 kg
	78007
	10087315
	K036
	
	M16x1.5: max. 130 Nm
	M16x1.5: max. 20 Nm
	M24x1.5: max. 25 Nm

### OE Manufacturer/Part No.

Manufacturer	Original Part No.	Model
Mercedes	942 320 06 57	
Mercedes	942 320 17 21	

Mercedes	942 320 25 21	
Mercedes	942 320 71 21	
Mercedes	A 942 320 17 21	Actros
Mercedes	A 942 320 17 21	Actros
Mercedes	A 942 320 25 21	Actros MP2
Mercedes	A 942 320 71 21	Actros MP2
Mercedes	A 942 320 06 57	Actros MP2
Mercedes	A 942 320 71 21	Actros MP2
Mercedes	A 942 320 25 21	Actros MP2
Mercedes	A 942 320 06 57	Actros MP2