

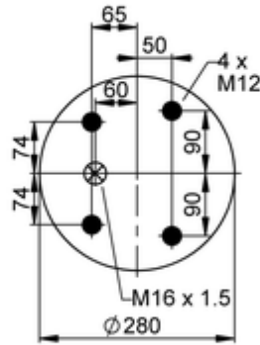

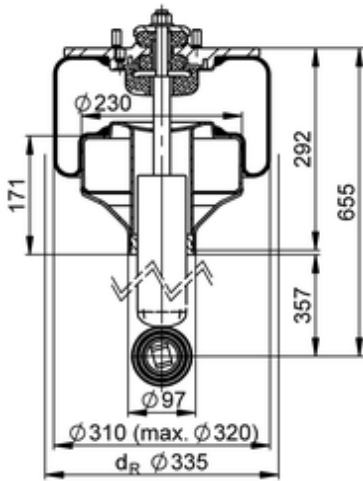



1416 N P05

601606



-  bolt or stud
-  hole
-  combination stud
-  air inlet
-  stud and nut

	19,9 kg
	1416 N P01
	1416 N P15
	
	M12: max. 70 Nm
	M16x1.5: max. 20 Nm

**OE Manufacturer/Part No.**

Manufacturer	Original Part No.	Model
IVECO Bus	5801983973	City Bus
IVECO Bus	504113183	City Bus