

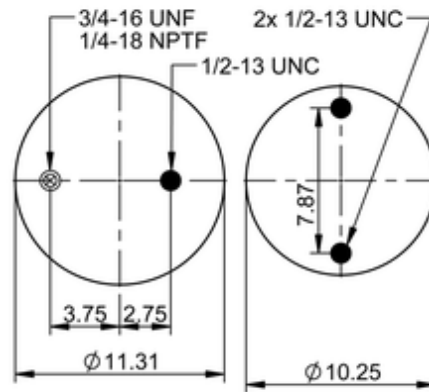

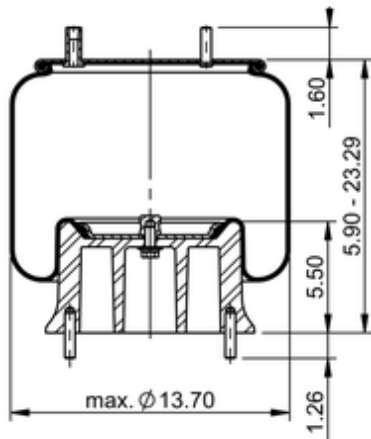



11 10.5-17 A 133

77754



 lb	20.1 lb
	9305216
	1/2-13 UNC: max. 35 lbf ft
	1/4-18 NPTF: max. 22 lbf ft
	3/4-16 UNF: max. 50 lbf ft

Cross-reference

TRP	AS01333
Automann	1D28G-A133

OE Manufacturer/Part No.

Manufacturer	Original Part No.	Model
--------------	-------------------	-------

SAF Holland

90557392